

Considerations for the Utilization of NiMH Battery Technology in Stationary Applications.

Cobasys
Orion, MI

ABSTRACT

The market demand for higher reliability, long life and consistent performance is fueling the demand for advanced energy storage technologies for use in a broad range of applications. Nickel metal hydride (NiMH) is one of the promising capable battery technologies that can satisfy the needs of a broad variety of energy storage applications. In order to get the benefit of using NiMH battery technology, there must be a good match between the strengths of the technology and the needs of the applications. There are countless stories where the promise of better performance, life, cost, etc. was not realized due to the miss-match between technical capability and application requirements.

NiMH battery technology was initially introduced to the consumer market to satisfy the demand for higher energy density than was available using nickel cadmium battery technology. It has since evolved into the technology of choice for such applications as hybrid electric vehicles and power tools. As a newcomer to the stationary battery world, NiMH offers significant advantages for many applications. These advantages include high power and energy density, very good cycle and calendar life, and unique packaging and interface methods. In order to provide optimum performance, the attributes of NiMH battery technology must be taken into proper consideration during system design and subsequent application. This paper will discuss the NiMH technology, how some of the application challenges have been met and the benefits it provides to some specific applications.

INTRODUCTION

The NiMH battery started its life as an evolution from the nickel hydrogen battery used in aerospace applications. Because of their exceptional cycle life and reasonable specific energy, nickel hydrogen batteries were attractive for aerospace applications; however nickel hydrogen batteries have poor volumetric efficiency and require tanks of compressed hydrogen gas and other expensive materials. NiMH batteries are the result of configuring a battery using metal hydride hydrogen storage materials as one of the battery electrodes. NiMH batteries have been in development for well over twenty years, but were mere laboratory curiosities before the development of metal hydride electrodes that were capable of being charged and discharged in a cell environment without failure. The concerns over the cadmium content in NiCd consumer cells also contributed to accelerating the development of NiMH batteries since the processing, construction methods, and electrical characteristics are quite similar between the two technologies.

As NiMH battery technology achieved a significant level of maturity, it became an enabler for many applications. NiMH technology was a serious contender in the laptop and cellular phone battery market before the lithium technologies achieved a level of commercialization to be viable for those applications. NiMH has several unique aspects compared with traditional batteries currently employed in stationary service. Among these are high power and energy density resulting in smaller footprints, excellent cycle life, fairly environmentally benign materials, and the ability to operate over a reasonably wide temperature range while retaining good performance. Although not a panacea, NiMH, when properly applied to a situation, can be an excellent candidate for applications in stationary service traditionally served by other technologies. However, in order to apply the technology appropriately, a thorough understanding of the application requirements, the limitations of the technology, and the environment in which the system is to function are essential for success.

Because of the existing infrastructure for many stationary applications, the NiMH technology should not demand special treatment on the part of the customer installation. For this reason NiMH batteries are best deployed using a system engineering approach. The batteries should be integrated with all subsystems necessary to make it look to the connected equipment as electrically similar to the battery it was intended to connect to as possible and to ensure proper charge and discharge operation within the parameters of the application.

This paper will discuss some background of nickel metal hydride batteries and then will illustrate a system level approach to a large stationary battery installation where the NiMH battery was to replace an existing vented lead acid (VLA) system.

NIMH TECHNOLOGY

The NiMH battery is termed an alkaline storage battery due to the use of potassium hydroxide (KOH) as the electrolyte. Electrically, NiMH batteries are very similar to nickel cadmium batteries. Rechargeable alkaline storage batteries have become prevalent in various markets for several technically important reasons:

- High electrolyte conductivity allows for high power applications
- The battery system can be sealed, minimizing maintenance and leakage issues
- Operation is possible over a wide temperature range
- Long life characteristics
- High energy density and specific energy¹

NiMH batteries have been developed to respond to a number of specific market requirements such as recyclability, high power, high energy density, long life, and other important characteristics for consumer and OEM applications. They are suitable in many applications where high currents and/or deep discharges are required.

The NiMH battery is capable of supplying a large quantity of power to the load. Specific powers of from 200W/kg to greater than 1000 W/kg are available from currently available designs. NiMH batteries exhibit a very linear resistance characteristic for discharge and charge at any given SOC.² This simplifies modeling the battery behavior for applications in electric vehicles and other high energy and high power applications.

NiMH batteries can be fabricated in sizes from tens of milliampere hours to hundreds of ampere hours or more. Due to the compatibility of steel with the KOH electrolyte, the batteries can be manufactured in steel cans which are very rugged and exhibit good thermal performance. Large energy storage systems for a variety of applications ranging from transportation to backup power and distributed storage have been successfully applied using NiMH technology. This versatility is constantly leading to new applications for NiMH batteries.

Cell Operation

The active materials in the NiMH battery are composed of metal compounds or metallic oxides. The nickel oxide – hydroxide electrode only exchanges a proton in the charge-discharge reaction and the electron transfer is very rapid contributing to high power capacity. The small change in size of the electrode between charge and discharge also results in mechanical stability and thus longer cycle life.³

The electrolyte, which is an aqueous solution of potassium hydroxide, has a very high conductivity and does not enter into the overall cell reaction to any significant extent. The electrolyte concentration (and therefore a major component of cell resistance) remains fairly constant over the entire range of state of charge or discharge. These factors lead to a battery with high power performance and long cycle life.

The positive electrode of the NiMH battery is a nickel substrate in the form of nickel foam, felt, perforated sheet or other constructions with the active material nickel hydroxide pasted or sintered onto the substrate. This is a very well developed electrode material with 100 years of history and development since it is essentially the same composition as it is for NiCd batteries. Nickel based alkaline batteries are attractive since the nickel electrode can be fabricated with very large surface areas which lead to high capacities and high current densities. The electrolyte does not enter into the electrode reaction so that conductivity stays at a high level throughout the usable capacity of the battery. In addition the nickel active material is insoluble in the KOH electrolyte leading to longer life and better abuse tolerance. Only a proton is involved in the charge/discharge reaction leading to very small density changes and improved mechanical stability of the electrode during cycling. Also the gravimetric and volumetric energy densities are very good for the nickel electrode.² Materials such as Ca(OH)₂, Y₂O₃, CoO, and others may be added to the Ni(OH)₂ in small quantities to enhance the charge acceptance and conductivity of the active material.⁴ The electrode potential for the nickel electrode is about +0.44 V (Relative to Hg/HgO reference electrode)⁵. The simplified nickel electrode reaction in the cell is:

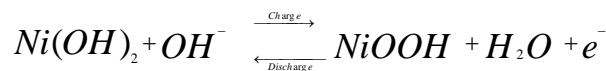

The negative electrode is the metal hydride (MH) electrode. This electrode is composed of a metal hydride material which has a fairly negative potential of around -0.9 V (Relative to Hg/HgO).⁵ Many elemental metal hydride materials exist but were not practical for battery applications due to the high equilibrium pressure exhibited by these materials at room temperature. This changed when intermetallic compounds were developed that combined strong and weak hydride forming materials. Tailoring the metal hydrides for the desired equilibrium pressure and other chemical properties is achieved by adjusting the ratio between these two types of material components. The most common material used in NiMH batteries today is an AB₅ alloy where both the A and the B components consist of a variety of compounds alloyed together. The reactions for the negative electrode can be written as:

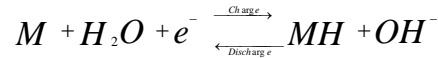

Where, M represents the metal hydride material.

The complete cell is represented schematically in Figure 1 below. The combined whole cell reaction can be written as:

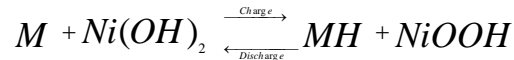

From the individual cell potentials it shows that the open circuit potential should end up around 1.3 V per cell, which it indeed does. A typical charge and discharge curve for the NiMH cell is shown in Figure 2.

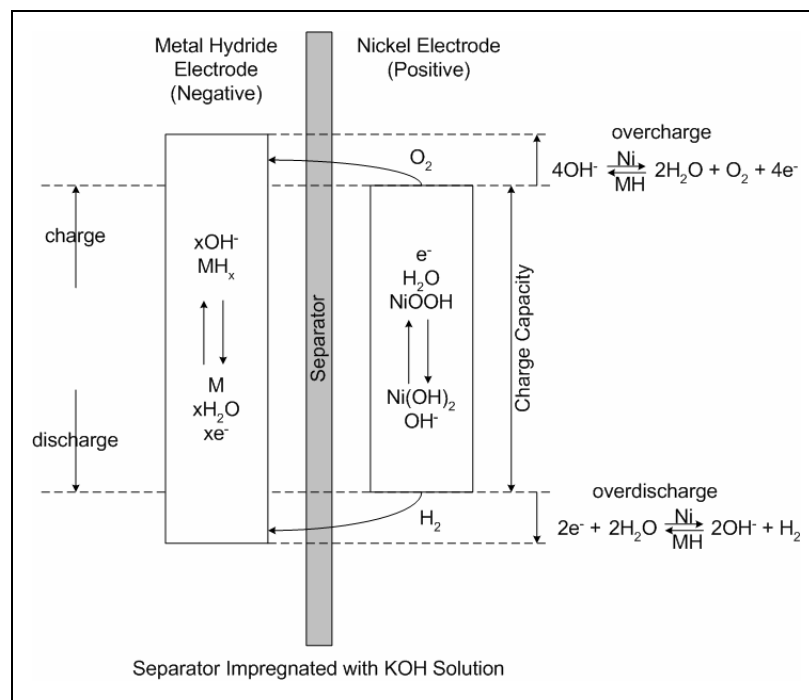

Figure 1. Schematic representation of NiMH cell⁵

Overcharge and Overdischarge Reactions

The NiMH battery also has over-charge and over-discharge reactions that allow the battery to handle abuse conditions of overcharge and overdischarge without severe adverse effects. This is the oxygen recombination reaction for overcharge. On over-discharge the battery also has a recombination reaction that takes place.

The oxygen recombination reaction takes place as follows on overcharge:

For the positive (Ni) electrode OH⁻ ions are oxidized generating oxygen: $4OH^- \Rightarrow 2H_2O + O_2 + 4e^-$

For the negative (MH) electrode the oxygen is reduced: $2H_2O + O_2 + 4e^- \Rightarrow 4OH^-$

The net result is heat generation from the reaction equal to the energy input. This occurs at the expense of increasing the stored charge in the battery. If the rate of charge input exceeds the rate of recombination, an increase in cell pressure will result. In extreme cases of overcharge the cell can become pressurized enough to vent.

For the case of overdischarge hydrogen is evolved on the positive and recombined at the negative.

For the positive electrode water is reduced and hydrogen gas is formed: $2H_2O + 2e^- \Rightarrow H_2 + 2OH^-$

The hydrogen gas is then oxidized at the negative (MH) electrode: $H_2 + 2OH^- \Rightarrow 2H_2O + 2e^-$

Net result is no reaction but heat and some pressure are generated in the cell. The ability of the NiMH cell to tolerate overdischarge is very important for large series strings of batteries since capacity mismatches may allow some cells to be overdischarged.

To ensure that the overcharge and overdischarge reactions function properly and thus control the buildup of cell pressure, the NiMH battery is constructed with the Ni electrode as the capacity limiting electrode and the MH electrode with excess capacity for both charge and discharge to allow for the recombination to take place. This is shown schematically in Figure 1.

The NiMH cell is a starved electrolyte design meaning that the electrolyte is absorbed into the separator material and pores in the plates, there is no “free” liquid in these cells. This is another crucial contribution to the function of the recombination reactions because the separator easily allows the gas generated at one electrode to pass to the other electrode where it can recombine.

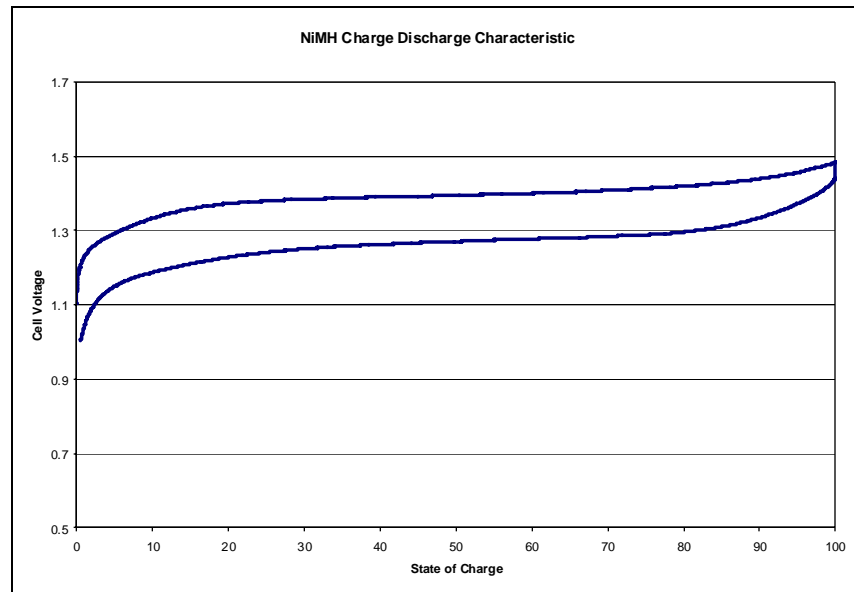

Figure 2. Charge discharge of high power NiMH cell at the one hour rate (1C)

Self Discharge

NiMH batteries, like all batteries, have a certain level of self discharge that occurs when the battery is at rest. The self discharge characteristic typical of an electric vehicle type battery module is shown in Figure 3. The contribution to self discharge from recombination is negligible below about 70% - 80% state of charge. Longer term contributions to self discharge are caused by chemical ion shuttles which continuously discharge the cell over longer periods of time. The rate of the self discharge is highly dependent on the temperature of the cell. Higher temperatures yield higher self discharge rates.

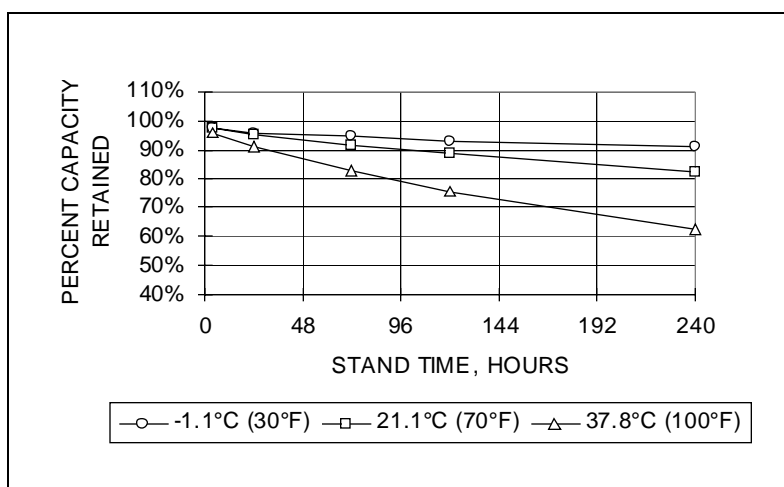

Figure 3. Capacity retention at several temperatures for a NiMH EV battery⁶

Failure Mechanisms

NiMH batteries exhibit certain failure mechanisms that determine the end of life of the battery. Some of these mechanisms can be catastrophic (i.e. render the battery inoperative) while others are a natural part of use and aging of the materials in the cell.

The primary criterion used for end of life in many applications is the point at which the battery capacity has faded below 80% of its rated capacity. This occurs due to corrosion of the negative plate material (metal hydride) throughout the useful life of the battery.⁶ The NiMH battery does not exhibit a catastrophic “falling off the cliff” type of capacity loss due to this corrosion as some other technologies exhibit. This is because the metal hydride active material is very conductive, so gradual corrosion results in loss of capacity, and some loss in power capability due to the consumption of water in the electrolyte during corrosion, but does not result in a failure of the negative plate or loss of conductivity with the active material.

Another end of life criterion is power fade of the battery. Power fade and capacity fade are two different but somewhat related phenomena. Power fade is caused by the loss of water in the electrolyte due to a variety of factors. The most severe cause of water loss (sometimes called separator dry-out) is caused by operating the battery in abusive conditions causing the safety vent to open and release electrolysis gasses from the cells. A gradual fade of power is also caused by the normal aging and water consumption caused by negative corrosion.⁷ Since the NiMH battery has considerable power capability, this condition may not affect operation in some applications until the capacity fade deems the battery at end of life. However, power fade may be the limiting factor on life in applications such as hybrid and electric vehicles, UPS applications, and other high rate applications. Another contribution to water loss in the battery can be diffusion through the case (in the case of plastic NiMH cells), however this is not a problem with the steel can construction method.

The aging of the battery occurs both due to calendar time and cycling use of the battery. NiMH battery cycle life has been steadily improving over the course of its development history. NiMH batteries routinely provide well over 1000 deep discharge cycles and in shallow state of charge (SOC) swing applications (such as hybrid electric vehicle and certain power quality applications) the cycle life can be many hundreds of thousands of cycles. The calendar life for NiMH batteries has not been definitively established at this time due to the length of time the technology has been available, but indications from accelerated life testing conducted to date place the calendar life at greater than 10 years, some tests report projected life of greater than 15 years at 30°C.⁸ Some testing reported by Southern California Edison on NiMH batteries originally designed for electric vehicle applications extrapolated their potential usable life of over 25 years at 35°C in a substation switchgear application.⁹

Catastrophic failure modes for the NiMH battery are usually caused as a result of abuse in the application. If the battery is charged improperly from a voltage source that is not properly controlled or current limited, the battery can be put in a condition of continually running in a state of oxygen recombination. This condition takes all of the input energy and produces heating. If the condition is allowed to persist the battery can heat itself to a point where the separator material fails and the cell will short circuit, producing more heat and subsequent venting of electrolyte and gas. Obviously this is an undesirable condition, which makes charge management of the battery an essential component of any useful battery system. If the battery does not heat to the point of separator failure, venting of electrolyte due to the overcharge abuse can severely shorten the useful life of the battery.

As a general rule, the life of the NiMH battery, as with most other battery technologies, is dependent on observation of proper charging methods and avoidance of overdischarge. Optimum charging of NiMH batteries requires a different approach from many other technologies due to the nature of the sealed recombinant design and the unique reaction kinetics responsible for charge and discharge. This makes a “smart battery” concept the obvious choice for development of NiMH batteries for stationary applications where it must exist in an environment designed for other battery technologies such as lead acid.

The nickel metal hydride battery has been shown to be a battery that can handle severe physical and electrical abuse without causing safety risks. Extensive testing was performed by the automotive industry before acceptance of the technology for use in electric vehicles and hybrid electric vehicles.

Construction

Currently, several styles of NiMH cell / battery construction are available in the market. These constructions include cylindrical cells of various sizes, as well as prismatic designs. The prismatic battery designs are available in both multi-cell modules composed of steel or plastic enclosed single cells and monoblock construction with internal cell to cell connections. The monoblocks are typically manufactured using a plastic case material. Hybrid electric vehicle and EV batteries may also incorporate liquid cooling jackets as part of the module design to allow for dissipation of the heat generated by high power (20C) charge and discharge rates. A cutaway of a steel can prismatic cell is shown in Figure 4 below.

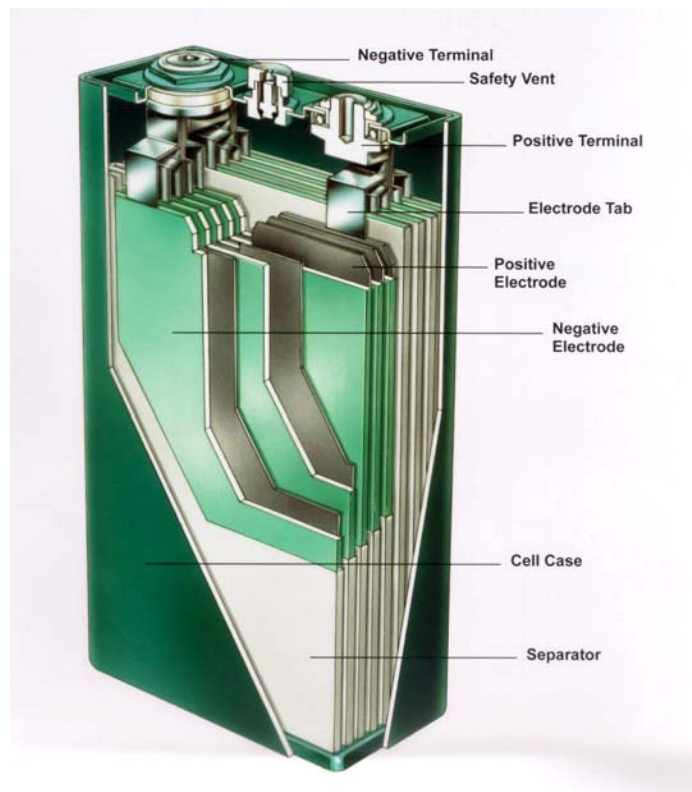

Figure 4. Cutaway view of prismatic NiMH cell¹

TRADITIONAL NIMH APPLICATIONS

NiMH has developed to a high state of maturity for a variety of commercial applications including automotive and consumer applications. Other applications include aerospace, military, and industrial use. In Europe NiMH is already finding application in replacing NiCd cells in standby lighting apparatus.

NiMH batteries have been used in several different implementations of electric vehicles including the DaimlerChrysler EPIC, the GM EV-1 and electric S10, and the Toyota RAV4EV. Today's leading application for NiMH batteries in the automotive community is the hybrid electric vehicle with examples such as the Toyota Prius, Honda Insight, and the Ford Escape hybrids. Interest in NiMH technology for hybrid vehicles is expanding to heavy duty vehicles and buses due to its potential for the high power and cycle life required for the power assist applications.

The NiMH consumer cell was developed to replace sealed NiCd cells used for portable electronics. With 30% to 50% better energy density the NiMH cell quickly caught on for applications such as cell phones and portable computers. Although the lithium technologies have replaced the NiMH cell in the cell phone and laptop markets, the continuous improvement in the specific power of the NiMH technology has led to its adoption in cordless drills and other such power tools. The ability of NiMH to be rapidly charged and deep discharged at high rates combined with good energy density has led to the broad use of NiMH in consumer applications and continually leads to new applications that take advantage of its characteristics.

NIMH SOLUTIONS FOR STATIONARY APPLICATIONS

NiMH batteries have some unique characteristics that make field application of the technology more complicated than simply replacing some other type of battery with NiMH and adjusting the charging voltage.

The stationary battery landscape has been dominated by lead acid batteries of various constructions for the past century. It was the obvious choice in many instances due to its comparatively low cost and where space was not a limitation. However, due to growing requirements for adding capacity to existing installations or the desire of facility management to utilize a new or more "green" technology, other battery technologies are being considered for applications that have been classically the domain of vented lead acid (VLA) or valve regulated lead acid (VRLA) batteries.

To apply NiMH batteries to a stationary application, consideration must be given to the duty cycle and specific requirements of the application. Because the stationary market is pre-existing, creating a system that will function within the parameters of other battery technologies is a key concern. Since most stationary systems utilizing lead acid batteries (either VLA or VRLA) are charged with constant potential charging systems, a way of managing this charging method to be compatible with the NiMH technology must be provided as a part of the solution.

One approach to this issue is to provide discrete building blocks which can be put together in various combinations to achieve the desired operating voltage and reserve time for the application. Each of the building blocks manages the charging operation for its own set of cells. This approach has proven to be effective in the application of this technology. We will discuss one for an Uninterruptible Power Supply (UPS) system currently in operation.

Case Study – UPS Battery Replacement

A need for a replacement UPS battery system was identified and a design to meet the performance requirements was created. The system had to be designed within certain constraints of the existing VLA battery system that it would be replacing. These constraints included the necessary run time of the system (15 minutes), at the desired UPS power level (560 kW for each of 3 separate and redundant UPS devices). The charging voltage and system end voltages were also primary concerns, since the NiMH battery has somewhat different charge and discharge voltage characteristics than the VLA battery it would be replacing.

The system design resulted in the determination that a battery system composed of a series parallel arrangement of building block units would be used. This resulted in an equivalent of 300 NiMH cells in series which in turn would be in parallel with six other strings for a total of seven parallel strings for a total of 2100 cells in the battery system for each UPS device. This system charges from the UPS rectifier at a float voltage of 420 VDC utilizing the end of discharge cutoff voltage of 300 VDC. The cells were segregated into the building blocks in either 24 VDC (20 cell) or 48 VDC (40 cell) increments. Since the 48 VDC building block units have a capability of 10.8 kW of discharge power for 15 minutes, and the 24 VDC building blocks have a capability of 5.4 kW for 15 minutes, it was determined that forty-nine (49) 48 VDC building blocks and seven (7) 24 VDC building blocks would be required for each UPS system. These units were arranged in a 19" rack mounted system where each rack contained seven of the same voltage building blocks in parallel. The racks of parallel building blocks were then connected in series to achieve the operating voltage.

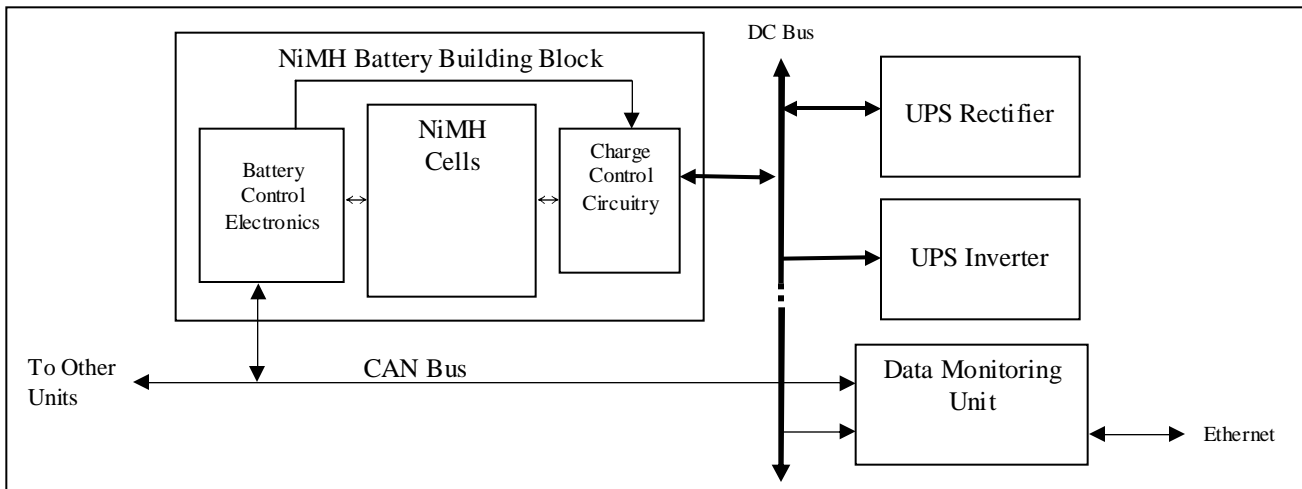

Figure 5. Block diagram of UPS battery unit implementation

The series-parallel arrangement and the design of the building blocks provided several unique features for the system, including an additional level of redundancy for the battery system. The building blocks were designed to plug into a bus bar back plane system in the racks and to allow for hot insertion and removal from the system. This simplifies maintenance requirements if a building block should require service or replacement, since the UPS system can remain on-line while this is done with the minimal loss of reserve time due to the removal of one building block. When the building block is inserted, the battery management electronics brings the unit online once it has detected that it is fully engaged with the back plane. As many building blocks as desired can be placed in parallel to achieve the level of redundancy and fault tolerance desired in the application. A drawing of the battery string interconnection method is shown below.



Figure 6. Interconnection of building blocks in series / parallel arrangement

The building blocks were designed with ease of maintenance, safety, and serviceability of the system in mind, so each building block has indicator LEDs that allow a quick determination of its status. If the electronics detects a fault in the building block it will indicate this on the front panel and remedial action can be initiated. In addition, the electronics provides an interface where the status can be continually monitored and data reported remotely.

The complete UPS / battery system has three NiMH battery strings supporting three independent, redundant UPS devices. The following diagram shows the space savings realized by the system compared to the previous battery system. This space savings has allowed the user to regain valuable space in his building and was a primary concern of the facility manager.

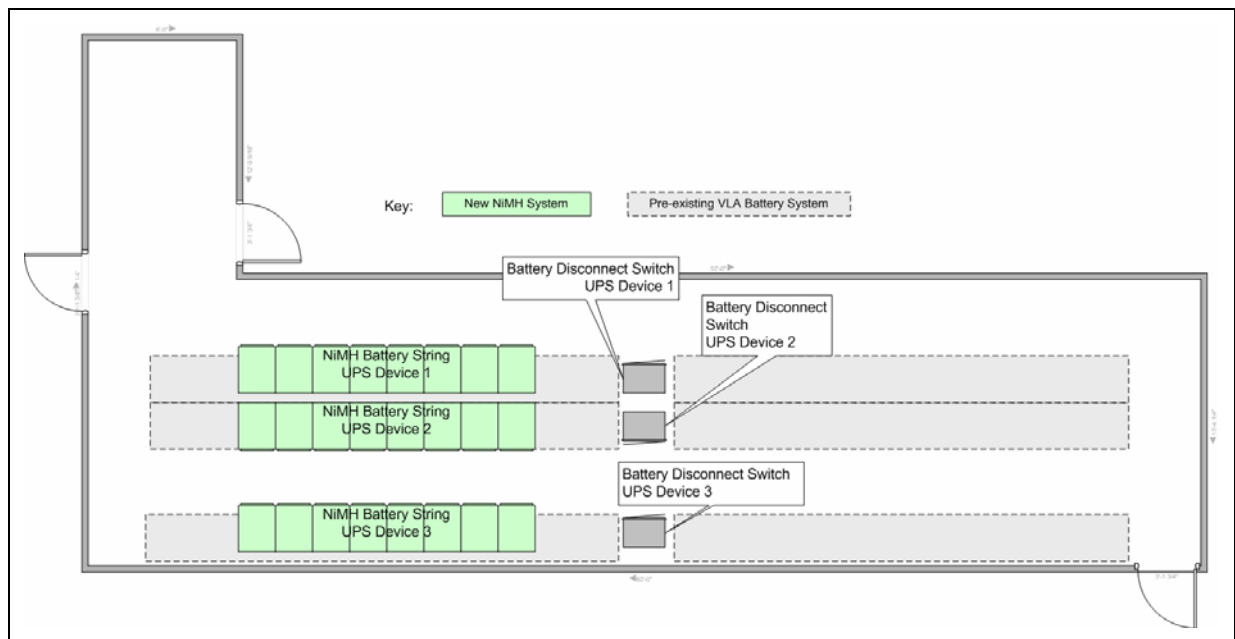

Figure 7. UPS battery room layout showing space savings for NiMH battery system.

The system has been in continuous operation for nine months at the time of this writing and has experienced numerous incidences of operation on UPS power with no reports of performance issues. One of the discharge incidences lasted up to 20 minutes (the load on the UPS system is not at full capacity) due to an issue with the building switchgear.

Other stationary applications in testing for NiMH batteries include peak shaving systems, photo-voltaic energy storage, and telecommunications backup power.

CONCLUSION

It can be seen that NiMH battery technology has progressed considerably since its introduction as a consumer product in the 80's. Many commercial applications, such as power tools and hybrid electric vehicles, have currently taken advantage of NiMH technology, however stationary applications have been slower to appear due to the need to match the application requirements with the new characteristics of the technology. As illustrated in the example of the UPS system, using a systems approach and proper attention to the application details, a new technology such as NiMH can fulfill its promises and be available to provide the beneficial aspects of the technology to other stationary applications such as telecommunications, distributed energy storage, and others that have only begun to appear.

REFERENCES

1. Kopera, J J C, "*Inside the Nickel Metal Hydride Battery*," Texaco Ovonic Battery Systems, 2002.
2. Linden, D, Reddy, T B, "*Handbook of Batteries*," pp.29.1-30.37, McGraw-Hill Companies, Inc., 2002.
3. Trumbore, F A, ed., "*Modern Battery Technology*," Center for Professional Advancement, 1995
4. Ikoma, M, Hamada, S, Morishita, N, Hoshina, Y, Matsuda, H, Ohta, K, Kimura, T, "*Development of A Nickel/Metal Hydride Battery (Ni/MH) System for EV Application*," pp.370-380, The Electrochemical Society Proceedings, Vol.94-27, 1994.
5. Notten, P H L, "*Rechargeable nickel-metalhydride batteries: a successful new concept*," pp. 151-195, Interstitial Intermetallic Alloys, Kluwer Academic Publishers, 1995.
6. Hellmann, J V, "*Application Manual: Nickel Metal Hydride Battery, Electric Vehicle Application Model GMO-0900, GMO-0901 Revision A*," p.20, GM Ovonic, 1999.
7. Leblanc, P, Jordy, C, Knosp, B, Blanchard, P, "*Mechanism of Alloy Corrosion and Consequences on Sealed Nickel-Metal Hydride Battery Performance*," Journal of the Electrochemical Society, Vol. 145, No. 3, March, 1998.
8. Asakura, K, Hasui, H, Shimomura, M, Hirai, T, "*Long-Life Nickel-Metal Hydride Batteries as a Backup Power Supply for Telecommunications System – Prolongation of cell life and effect of thermal management*," pp. 662-666, INTELEC 2001 Proceedings, 2001.
9. Pinsky, N, Gaillac, L, Mendoza, A, Argueta, J, Knipe, T, "*Performance of Advanced Electric Vehicle Batteries in Stationary Applications*," pp. 366-372, INTELEC 2002 Proceedings, 2002.